

FEATURES

- Non Punch Through Silicon
- Isolated Copper Baseplate
- Low Inductance Internal Construction
- 1200V Rating
- 400A Per Module

APPLICATIONS

- High Power Inverters
- Motor Controllers
- Induction Heating
- Resonant Converters

The Powerline range of high power modules includes half bridge and single switch configurations covering voltages from 600V to 3300V and currents up to 4800A.

The GP400LSS12 is a single switch 1200V, n channel enhancement mode, insulated gate bipolar transistor (IGBT) module. The IGBT has a wide reverse bias safe operating area (RBSOA) ensuring reliability in demanding applications.

The module incorporates an electrically isolated base plate and low inductance construction enabling circuit designers to optimise circuit layouts and utilise earthed heat sinks for safety.

ORDERING INFORMATION

Order As:

GP400LSS12

Note: When ordering, please use the complete part number.

KEY PARAMETERS

| | | |
|---------------|--------------|--------------|
| V_{CES} | | 1200V |
| $V_{CE(sat)}$ | (typ) | 2.7V |
| I_C | (max) | 400A |
| $I_{C(PK)}$ | (max) | 800A |

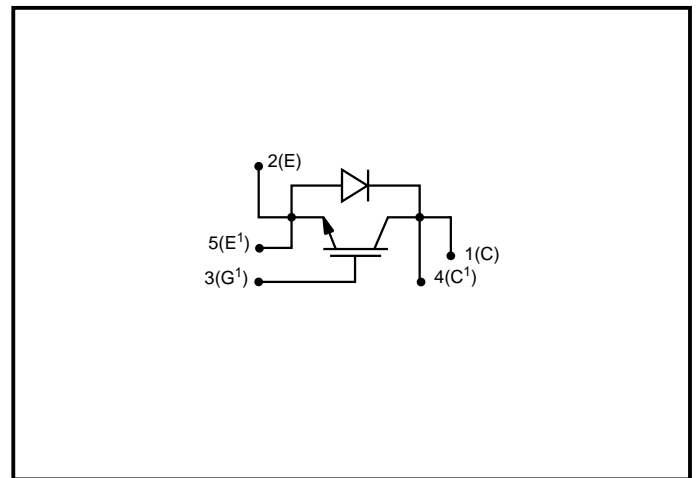

Fig. 1 Single switch circuit diagram

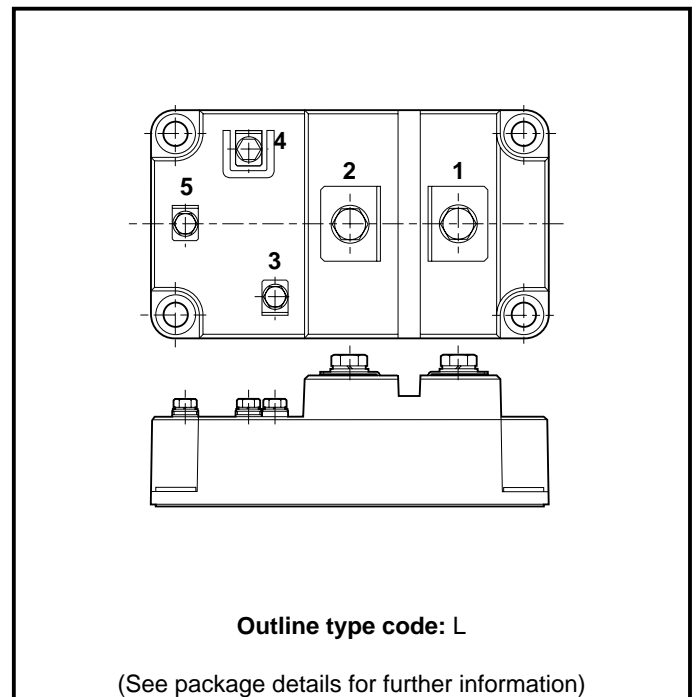

Fig. 2 Electrical connections - (not to scale)

ABSOLUTE MAXIMUM RATINGS

Stresses above those listed under 'Absolute Maximum Ratings' may cause permanent damage to the device. In extreme conditions, as with all semiconductors, this may include potentially hazardous rupture of the package. Appropriate safety precautions should always be followed. Exposure to Absolute Maximum Ratings may affect device reliability.

$T_{case} = 25^{\circ}\text{C}$ unless stated otherwise

| Symbol | Parameter | Test Conditions | Max. | Units |
|-------------|-----------------------------------|---|----------|-------|
| V_{CES} | Collector-emitter voltage | $V_{GE} = 0V$ | 1200 | V |
| V_{GES} | Gate-emitter voltage | - | ± 20 | V |
| I_C | Collector current | DC, $T_{case} = 75^{\circ}\text{C}$ | 400 | A |
| $I_{C(PK)}$ | Peak collector current | 1ms, $T_{case} = 80^{\circ}\text{C}$ | 800 | A |
| P_{max} | Max. transistor power dissipation | $T_{case} = 25^{\circ}\text{C}$, $T_j = 150^{\circ}\text{C}$ | 2980 | W |
| V_{isol} | Isolation voltage | Commoned terminals to base plate. AC RMS, 1 min, 50Hz | 2500 | V |

THERMAL AND MECHANICAL RATINGS

| Symbol | Parameter | Test Conditions | Min. | Max. | Units |
|---------------|--|---|------|------|------------------------------|
| $R_{th(j-c)}$ | Thermal resistance - transistor | Continuous dissipation - junction to case | - | 42 | $^{\circ}\text{C}/\text{kW}$ |
| $R_{th(j-c)}$ | Thermal resistance - diode | Continuous dissipation - junction to case | - | 80 | $^{\circ}\text{C}/\text{kW}$ |
| $R_{th(c-h)}$ | Thermal resistance - case to heatsink (per module) | Mounting torque 5Nm (with mounting grease) | - | 15 | $^{\circ}\text{C}/\text{kW}$ |
| T_j | Junction temperature | Transistor | - | 150 | $^{\circ}\text{C}$ |
| | | Diode | - | 125 | $^{\circ}\text{C}$ |
| T_{stg} | Storage temperature range | - | -40 | 125 | $^{\circ}\text{C}$ |
| - | Screw torque | Mounting - M6 | - | 5 | Nm |
| | | Electrical connections - M4 | - | 2 | Nm |

ELECTRICAL CHARACTERISTICS
 $T_{case} = 25^{\circ}\text{C}$ unless stated otherwise.

| Symbol | Parameter | Test Conditions | Min. | Typ. | Max. | Units |
|---------------|--------------------------------------|--|------|------|---------|---------------|
| I_{CES} | Collector cut-off current | $V_{GE} = 0\text{V}, V_{CE} = V_{CES}$ | - | - | 1 | mA |
| | | $V_{GE} = 0\text{V}, V_{CE} = V_{CES}, T_{case} = 125^{\circ}\text{C}$ | - | - | 25 | mA |
| I_{GES} | Gate leakage current | $V_{GE} = \pm 20\text{V}, V_{CE} = 0\text{V}$ | - | - | ± 2 | μA |
| $V_{GE(TH)}$ | Gate threshold voltage | $I_C = 20\text{mA}, V_{GE} = V_{CE}$ | 4.5 | - | 6.5 | V |
| $V_{CE(sat)}$ | Collector-emitter saturation voltage | $V_{GE} = 15\text{V}, I_C = 400\text{A}$ | - | 2.7 | 3.5 | V |
| | | $V_{GE} = 15\text{V}, I_C = 400\text{A}, T_{case} = 125^{\circ}\text{C}$ | - | 3.2 | 4 | V |
| I_F | Diode forward current | DC, $T_{case} = 50^{\circ}\text{C}$ | - | - | 400 | A |
| I_{FM} | Diode maximum forward current | $t_p = 1\text{ms}, T_{case} = 80^{\circ}\text{C}$ | - | - | 800 | A |
| V_F | Diode forward voltage | $I_F = 400\text{A}$ | - | 2.2 | 2.4 | V |
| | | $I_F = 400\text{A}, T_{case} = 125^{\circ}\text{C}$ | - | 2.3 | 2.5 | V |
| C_{ies} | Input capacitance | $V_{CE} = 25\text{V}, V_{GE} = 0\text{V}, f = 1\text{MHz}$ | - | 45 | - | nF |
| L_M | Module inductance | - | - | 15 | - | nH |

ELECTRICAL CHARACTERISTICS

 $T_{\text{case}} = 25^{\circ}\text{C}$ unless stated otherwise

| Symbol | Parameter | Test Conditions | Min. | Typ. | Max. | Units |
|---------------------|-------------------------------|--|------|------|------|---------------|
| $t_{d(\text{off})}$ | Turn-off delay time | $I_C = 400\text{A}$ | - | 700 | 850 | ns |
| t_f | Fall time | $V_{GE} = \pm 15\text{V}$ | - | 120 | 160 | ns |
| E_{OFF} | Turn-off energy loss | $V_{CE} = 600\text{V}$ | - | 60 | 80 | mJ |
| $t_{d(\text{on})}$ | Turn-on delay time | $R_{G(\text{ON})} = R_{G(\text{OFF})} = 3.3\Omega$ | - | 600 | 750 | ns |
| t_r | Rise time | $L \sim 100\text{nH}$ | - | 150 | 200 | ns |
| E_{ON} | Turn-on energy loss | | - | 35 | 75 | mJ |
| Q_{rr} | Diode reverse recovery charge | $I_F = 400\text{A}, V_R = 50\% V_{CES},$ $di_F/dt = 2000\text{A}/\mu\text{s}$ | - | 30 | 40 | μC |

 $T_{\text{case}} = 125^{\circ}\text{C}$ unless stated otherwise

| Symbol | Parameter | Test Conditions | Min. | Typ. | Max. | Units |
|---------------------|-------------------------------|--|------|------|------|---------------|
| $t_{d(\text{off})}$ | Turn-off delay time | $I_C = 400\text{A}$ | - | 900 | 1100 | ns |
| t_f | Fall time | $V_{GE} = \pm 15\text{V}$ | - | 200 | 250 | ns |
| E_{OFF} | Turn-off energy loss | $V_{CE} = 600\text{V}$ | - | 85 | 100 | mJ |
| $t_{d(\text{on})}$ | Turn-on delay time | $R_{G(\text{ON})} = R_{G(\text{OFF})} = 3.3\Omega$ | - | 700 | 850 | ns |
| t_r | Rise time | $L \sim 100\text{nH}$ | - | 180 | 230 | ns |
| E_{ON} | Turn-on energy loss | | - | 55 | 80 | mJ |
| Q_{rr} | Diode reverse recovery charge | $I_F = 400\text{A}, V_R = 50\% V_{CES},$ $di_F/dt = 2000\text{A}/\mu\text{s}-1$ | - | 55 | 70 | μC |

TYPICAL CHARACTERISTICS

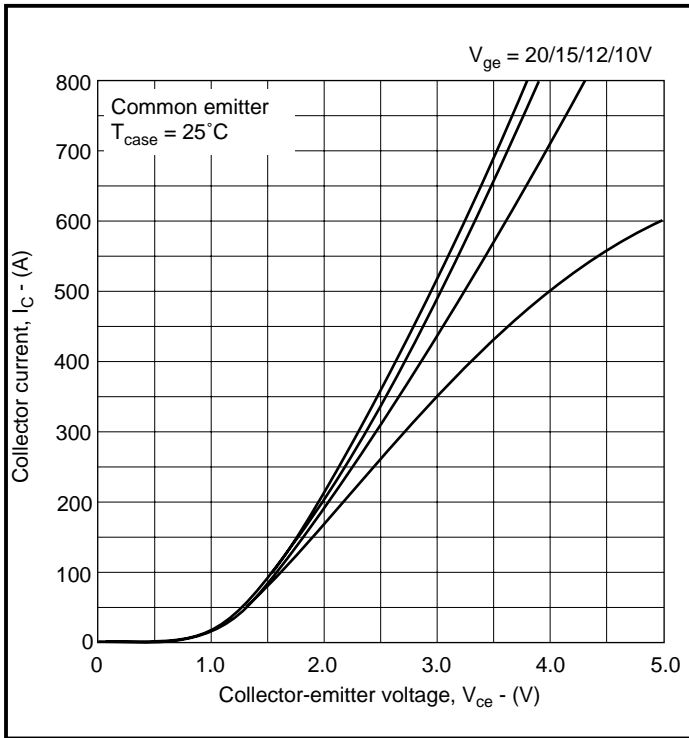

Fig. 3 Typical output characteristics

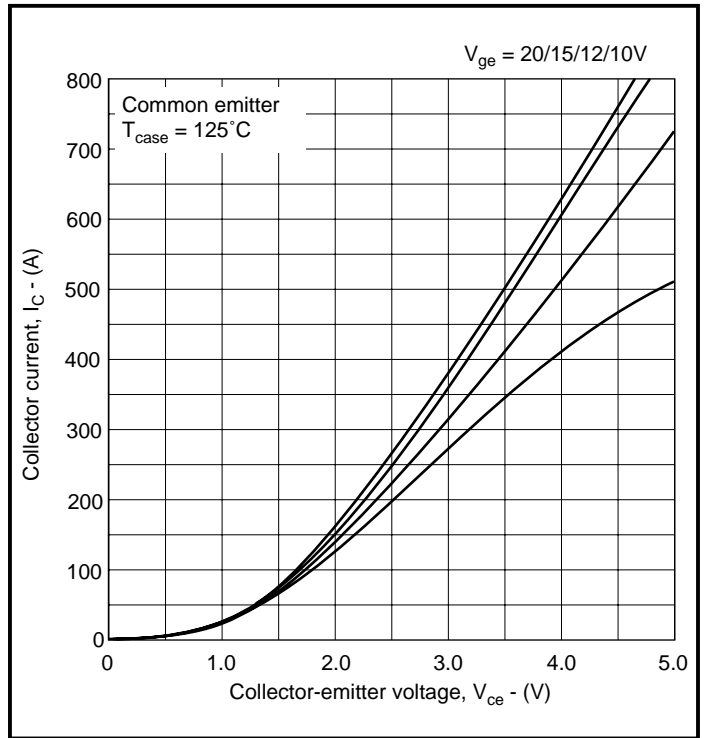

Fig. 4 Typical output characteristics

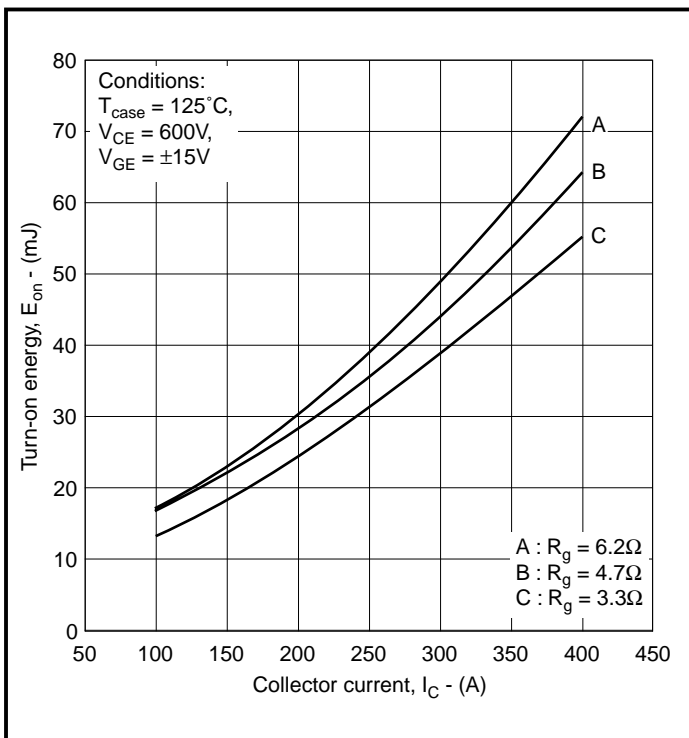

Fig. 5 Typical turn-on energy vs collector current

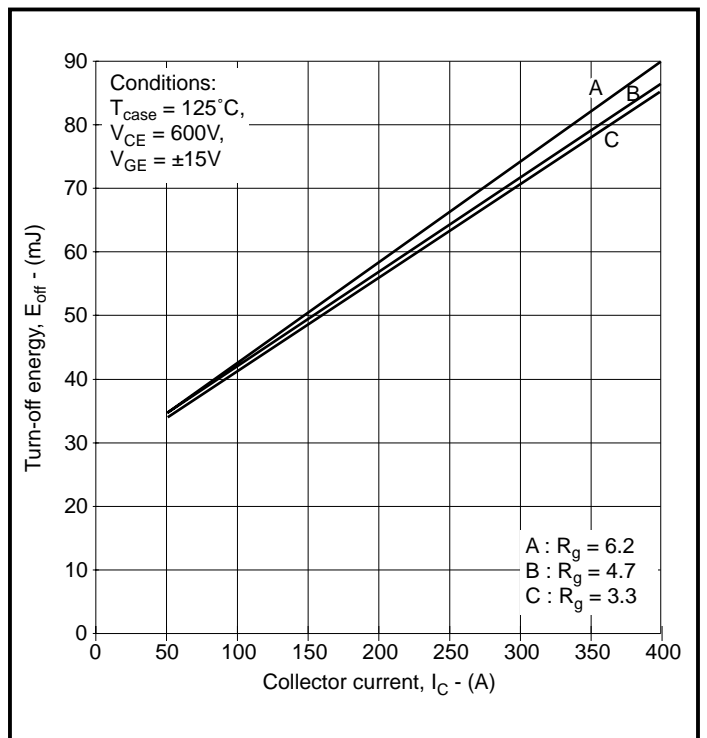

Fig. 6 Typical turn-off energy vs collector current

Caution: This device is sensitive to electrostatic discharge. Users should follow ESD handling procedures.

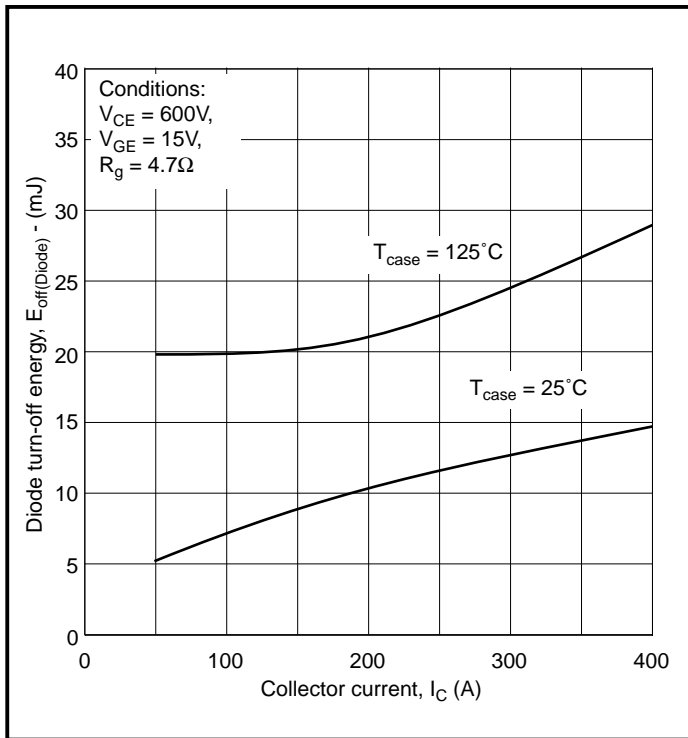

Fig. 7 Typical diode turn-off energy vs collector current

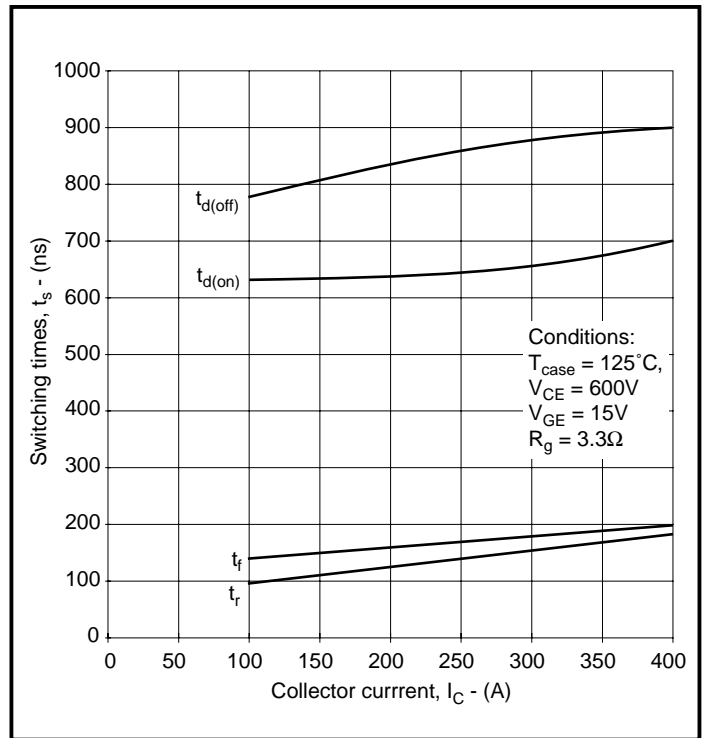

Fig.8 Typical switching characteristics

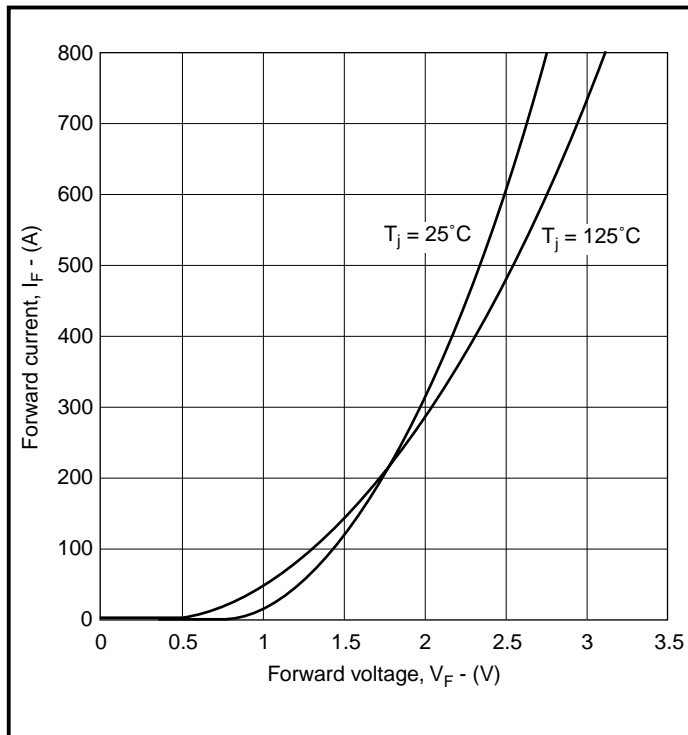

Fig. 9 Diode typical forward characteristics

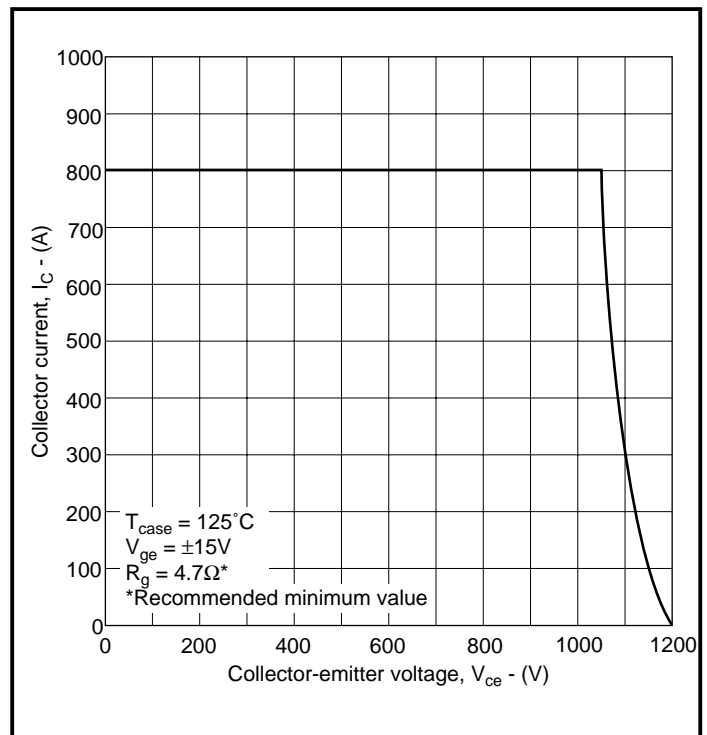

Fig. 10 Reverse bias safe operating area

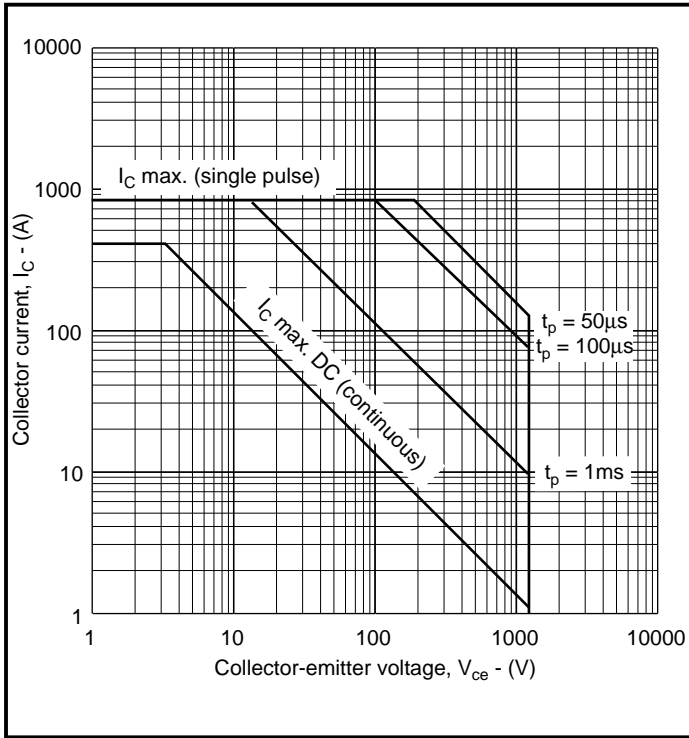

Fig. 11 Forward bias safe operating area

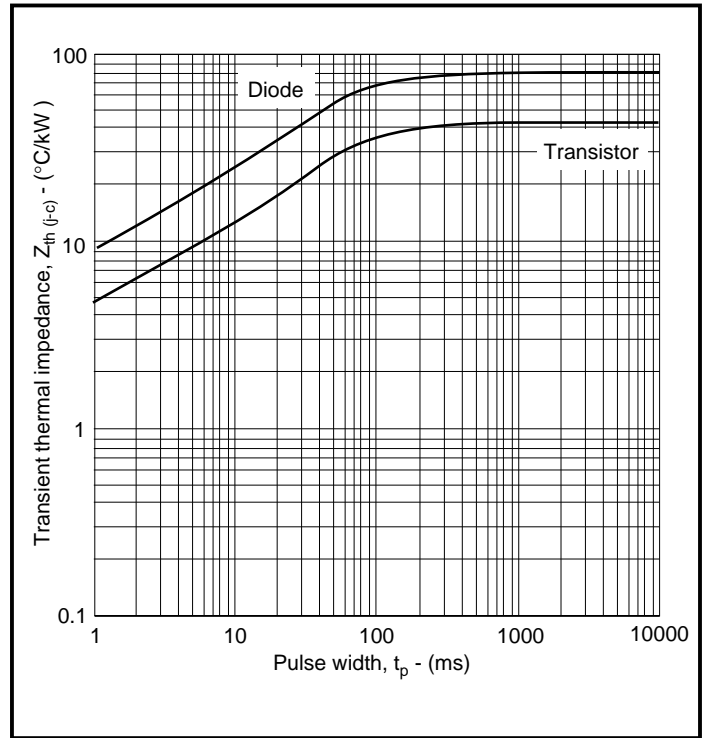

Fig. 12 Transient thermal impedance

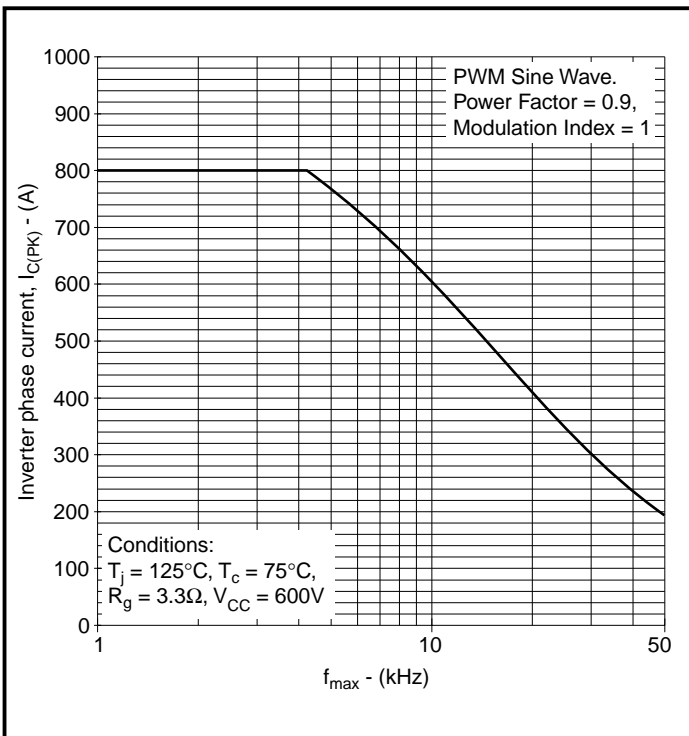

Fig. 13 3 Phase inverter operating frequency

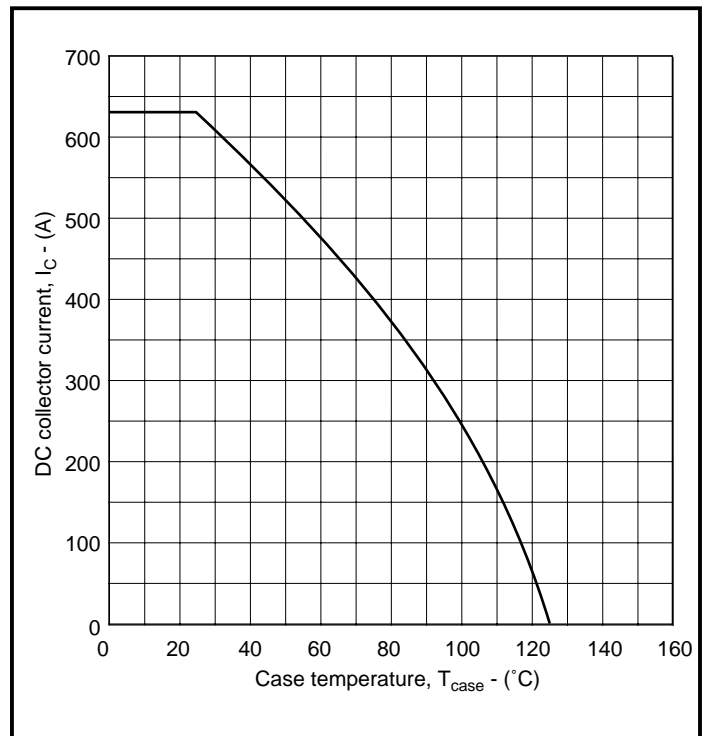
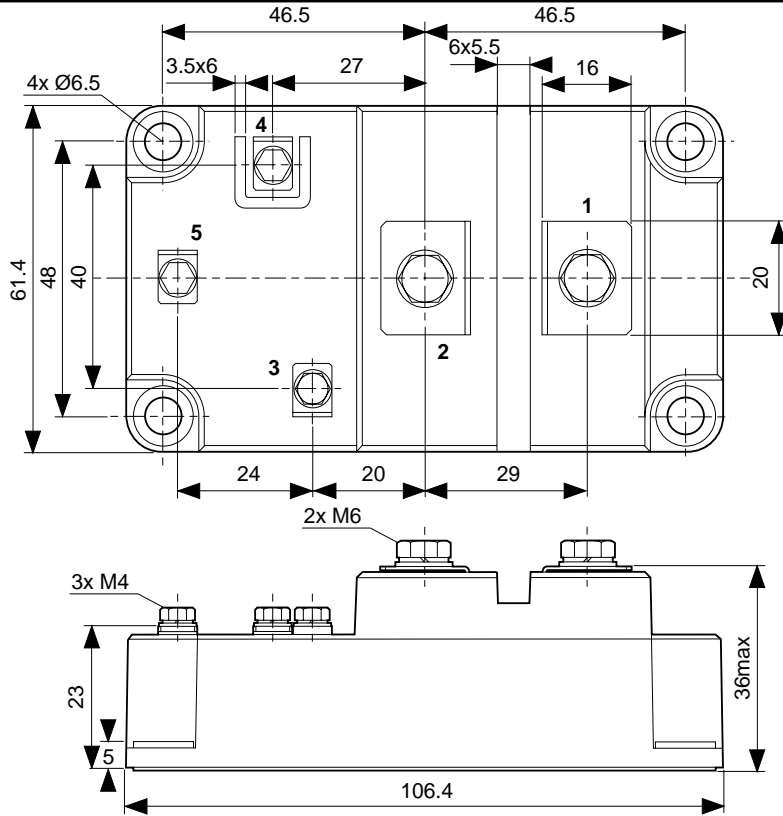

Fig. 14 DC current rating vs case temperature

PACKAGE DETAILS

For further package information, please visit our website or contact your nearest Customer Service Centre. All dimensions in mm, unless stated otherwise. DO NOT SCALE.



Nominal weight: 270g
 Recommended fixings for mounting: M6
 Recommended mounting torque: 5Nm (44lbs.ins)
 Recommended torque for electrical connections (M4): 2Nm (17lbs.ins)

Module outline type code: L

ASSOCIATED PUBLICATIONS

| Title | Application Note Number |
|--|------------------------------------|
| Electrostatic handling precautions | AN4502 |
| An introduction to IGBTs | AN4503 |
| IGBT ratings and characteristics | AN4504 |
| Heatsink requirements for IGBT modules | AN4505 |
| Calculating the junction temperature of power semiconductors | AN4506 |
| Gate drive considerations to maximise IGBT efficiency | AN4507 |
| Parallel operation of IGBTs – punch through vs non-punch through characteristics | AN4508 |
| Guidance notes for formulating technical enquiries | AN4869 |
| Principle of rating parallel connected IGBT modules | AN5000 |
| Short circuit withstand capability in IGBTs | AN5167 |
| Driving Dynex Semiconductor IGBT modules with Concept gate drivers | AN5384 |

POWER ASSEMBLY CAPABILITY

The Power Assembly group was set up to provide a support service for those customers requiring more than the basic semiconductor, and has developed a flexible range of heatsink and clamping systems in line with advances in device voltages and current capability of our semiconductors.

We offer an extensive range of air and liquid cooled assemblies covering the full range of circuit designs in general use today. The Assembly group continues to offer high quality engineering support dedicated to designing new units to satisfy the growing needs of our customers.

Using the latest CAD methods our team of design and applications engineers aim to provide the Power Assembly Complete Solution (PACs).

HEATSINKS

The Power Assembly group has its own proprietary range of extruded aluminium heatsinks. They have been designed to optimise the performance of Dynex semiconductors. Data with respect to air natural, forced air and liquid cooling (with flow rates) is available on request.

For further information on device clamps, heatsinks and assemblies, please contact your nearest sales representative or customer service office.



<http://www.dynexsemi.com>

e-mail: power_solutions@dynexsemi.com

HEADQUARTERS OPERATIONS
DYNEX SEMICONDUCTOR LTD
 Doddington Road, Lincoln.
 Lincolnshire. LN6 3LF. United Kingdom.
 Tel: 00-44-(0)1522-500500
 Fax: 00-44-(0)1522-500550

DYNEX POWER INC.
 Unit 7 - 58 Antares Drive,
 Nepean, Ontario, Canada K2E 7W6.
 Tel: 613.723.7035
 Fax: 613.723.1518
 Toll Free: 1.888.33.DYNEX (39639)

CUSTOMER SERVICE CENTRES
Central Europe Tel: +33 (0)1 58 04 91 00. Fax: +33 (0)1 46 38 51 33
North America Tel: 011-800-5554-5554. Fax: 011-800-5444-5444
UK, Scandinavia & Rest Of World Tel: +44 (0)1522 500500. Fax: +44 (0)1522 500020

SALES OFFICES
Central Europe Tel: +33 (0)1 58 04 91 00. Fax: +33 (0)1 46 38 51 33
North America Tel: (613) 723-7035. Fax: (613) 723-1518. Toll Free: 1.888.33.DYNEX (39639) /
 Tel: (949) 733-3005. Fax: (949) 733-2986.
UK, Scandinavia & Rest Of World Tel: +44 (0)1522 500500. Fax: +44 (0)1522 500020

These offices are supported by Representatives and Distributors in many countries world-wide.
 © Dynex Semiconductor 2000 Publication No. DS5306-2 Issue No. 2.2 October 2000
 TECHNICAL DOCUMENTATION – NOT FOR RESALE. PRINTED IN UNITED KINGDOM

Datasheet Annotations:

Dynex Semiconductor annotate datasheets in the top right hand corner of the front page, to indicate product status. The annotations are as follows:-

Target Information: This is the most tentative form of information and represents a very preliminary specification. No actual design work on the product has been started.

Preliminary Information: The product is in design and development. The datasheet represents the product as it is understood but details may change.

Advance Information: The product design is complete and final characterisation for volume production is well in hand.

No Annotation: The product parameters are fixed and the product is available to datasheet specification.

This publication is issued to provide information only which (unless agreed by the Company in writing) may not be used, applied or reproduced for any purpose nor form part of any order or contract nor to be regarded as a representation relating to the products or services concerned. No warranty or guarantee express or implied is made regarding the capability, performance or suitability of any product or service. The Company reserves the right to alter without prior notice the specification, design or price of any product or service. Information concerning possible methods of use is provided as a guide only and does not constitute any guarantee that such methods of use will be satisfactory in a specific piece of equipment. It is the user's responsibility to fully determine the performance and suitability of any equipment using such information and to ensure that any publication or data used is up to date and has not been superseded. These products are not suitable for use in any medical products whose failure to perform may result in significant injury or death to the user. All products and materials are sold and services provided subject to the Company's conditions of sale, which are available on request.

All brand names and product names used in this publication are trademarks, registered trademarks or trade names of their respective owners.